

Investigation of Charcoal Production Methods for Sajalices, Panama

**The Mangrove Charcoal
Sustainability Engineers for Sajalices**



International Senior Design 2010

Investigation of Charcoal Production Methods for Sajalices, Panama

Submitted To:

Michigan Technological University

Submitted By:

The Mangrove Charcoal Sustainability Engineers for
Sajalices (MCSES)

Wilbel Brewer

Aaron Cypher

Jonathan Gress

Samantha Neirby

Lauren Petitpren

Michigan Technological University
International Senior Design
Department of Civil and Environmental Engineering
Department of Chemical Engineering
Department of Mechanical Engineering
1400 Townsend Drive
Houghton, MI 49931



Disclaimer:

The Mangrove Charcoal Sustainability Engineers for Sajalices (MCSES) consists of students enrolled in a capstone design course at Michigan Technological University in Houghton, MI. Though the students worked under the supervision and with the guidance of faculty members and licensed engineers, the contents of this report should not be considered professional engineering.



Mission Statement:

The Mangrove Charcoal Sustainability Engineers for Sajalices (MCSES) will strive to design an oven for the commercial production of charcoal from mangrove trees. We will focus on producing a sustainable process that will protect and preserve the mangroves. We will also concentrate on optimizing the design, for low cost and high efficiency, as well as reducing harmful emissions and protecting the health of the workers.

MCSES: Wilbel Brewer, Lauren Petitpren, Aaron Cypher, Jonathan Gress, Samantha Neirby



Table of Contents:

1.0 Executive Summary	8
2.0 Introduction	10
3.0 Background	11
3.1 Location	11
3.2 Organizations	14
4.0 Technical Background	15
4.1 Pyrolysis	15
4.2 Wood Chemistry	16
5.0 Methods and Procedures	17
5.1 Overview	17
5.2 Data Acquisition	18
5.2.1 <i>ABC Tree Harvesting Method</i>	23
6.0 Alternative Design Options	24
6.1 Japanese Oven	24
6.2 Casamance Kiln	25
6.3 Brazilian Beehive	26
6.4 Retort Kiln	27
7.0 Process Design	28
7.1 Objectives	28
7.2 Overview	28
7.3 Unit Operation	30
7.3.1 <i>Firebox</i>	30
7.3.2 <i>Pyrolysis Chamber</i>	31
7.3.3 <i>Chimney</i>	31
7.4 Operation Stages	31
7.4.1 <i>Evaporation</i>	31
7.3-2 <i>Pyrolysis</i>	32
7.5 Batch Time	33
7.6 Byproduct and Recycle	35
7.7 Construction	39
7.8 Cost Estimation	40
8.0 Conclusion	42
9.0 Recommendations	43
10.0 Acknowledgements	44
11.0 References	45
12.0 Appendices	48



List of Figures and Images:

Figure 1: Locations visited in the country of Panama 11

Figure 2: Japanese Oven (Subterranean Kiln) sketch [7] 25

Figure 3: Casamance Kiln sketch [4],[8] 26

Figure 4: Brazilian Beehive sketch [4] 26

Figure 5: Adam Retort© Kiln Sketch [9,10] 27

Figure 6: MCSES retort with metal lid and chimneys..... 29

Figure 7: MCSES retort, interior shown 30

Figure 8: Stages of Pyrolysis, temperatures ranges taken from
 FAO Industrial Charcoal Making [11]..... 32

Figure 9: Unsteady-state heat conduction in a long cylinder [13]..... 35

Figure 10: MCSES liquid byproduct recovery versus temperature – liquid water recovery is
 shown on the secondary axis 38

Image 1: Approaching the island by boat 12

Image 2: A view of the mangrove forest from the island 13

Image 3: The Mangrove forest at low tide..... 14

Image 4: Temperature reading measured with a hand held thermocouple
 for the traditional oven 19

Image 5: Measuring dimensions of the traditional oven with a tape measure 20

Image 6: Measuring dimensions of the Japanese oven with a tape measure 20

Image 7: Determining the smoke density of the traditional oven from ten feet away 21

Image 8: Determining the smoke density by holding the
 smoke density chart next to the Traditional Oven 21

Image 9: MCSES members at a presentation given by United Nations (UN)
 on the mangrove forest 23



List of Tables:

Table 1: Wood chemistry for Asiatic mangrove –
 taken as a substitute for red mangrove [12] (Pettersen 1984).....36

Table 2: MCSSES anticipated product yields and corresponding energy content taken at
 component lower heating value.37

Table 3: Liquid byproduct recovery in lbs at operating conditions: 150°F and zero recycle39

Table 4: Total construction cost estimate of MCSSES retort40

Table 5: Labor analysis for MCSSES retort.....41

Table 6: Annual profit analysis of MCSSES retort.....42

Table 7: Overview of system performance and solutions to meet the specified criteria for
 MCSSES retort.....43



1.0 Executive Summary

In August 2010 the team traveled to Panama. The following report represents the information gathered while in Panama, as well as research completed afterwards. The compiled information led to the completed design of a charcoal producing oven.

While in Panama, MCSES partnered with a community in Sajalices, which produces charcoal from mangrove trees in a traditional method of open burning. The community members formed an organization, the United Defenders of the Sajalices Mangroves (DEUMSA), and teamed up with the United Nations Development Program (UNDP) and the Autoridad Nacional del Ambiente (ANAM) to develop a more sustainable charcoal production process. A household sized Japanese style subterranean oven for charcoal production was presented to the team as a possible improvement. However, the oven has not been tested or designed on a commercial size.

The team determined key criteria to focus the oven design upon, which led to a mission statement as follows: *The Mangrove Charcoal Sustainability Engineers for Sajalices (MCSES) will strive to design an oven for the commercial production of charcoal from mangrove trees. We will produce a sustainable process that will protect and preserve the mangroves. We will also optimize the design, for low cost and high efficiency, as well as reducing harmful emissions and protecting the health of the workers.*

With the completion of a new charcoal producing oven design, MCSES will propose their design to the community in Sajalices. If accepted by the community, the design can be put into use for charcoal production. If proven successful, the design may then be adopted in surrounding communities.

Through investigation and research, the MCSES team has identified that the retort kiln method best meets the needs and design requirements for Sajalices. The retort will be built with bricks and mortar above ground, and utilizes two chambers with a chimney for each chamber. The first chamber is where the fuel is burned to generate heat for the pyrolysis process. The other chamber



will contain the mangrove wood to be pyrolyzed into charcoal. It was determined that this recommended design had the potential to increase overall efficiency of charcoal production, reduce batch time, and provide for easier repair, reduced emissions, liquid byproduct recovery, and a commercial capacity of 1400 pounds of charcoal per batch. Implementing this design, would generate an estimated annual revenue of \$16,800 with an annual net profit of approximately \$4,400 per year. Total construction cost is estimated at \$2,400.



2.0 Introduction

The Mangrove Charcoal Sustainability Engineers for Sajalices (MCSES) was developed as part of the International Senior Design (IDesign) program at Michigan Technological University. The program is a capstone project for graduating seniors to demonstrate the technical information learned while at the university. The program is designed to give real world experience that applies skills acquired from an undergraduate education. MCSES contains members from both the Chemical Engineering and Mechanical Engineering Departments.

In August 2010, MCSES traveled to Panama and began research into charcoal producing ovens from mangrove trees for the town of Sajalices. The community had formed a small organization and found assistance through other groups to improve the charcoal production method. The community has already implemented reforestation initiatives and has learned of a new oven design, the Japanese subterranean oven. Charcoal production, despite the physical difficulties, is important to the community members as a source of income since other jobs are often unavailable. The charcoal is sold in 35-pound bags at grocery stores in Panama City. The community desires to produce charcoal in significant batches utilizing a method that will protect the workers and environment.

Data was collected in Panama through interviews, photographs, temperature readings, and physical measurements of the traditional and Japanese ovens. With this information, MCSES was able to begin a design that would meet the specified criteria. Assumptions on the composition of mangrove wood, wood densities, heat transfer coefficients of the oven bricks, the makeup of material used, and the pressure and heat of ovens in operation create a level of uncertainty in the design project that cannot be overcome by MCSES. The proposed oven design of MCSES is completed to the best of the team's ability, with limited information and no testing capabilities.

The MCSES design produce charcoal from mangrove trees at a low cost and high efficiency and while protecting the environment and workers. Background information and findings from



Panama are presented. A new oven design is proposed. Calculations are explained, along with a construction manual outlining the expected time to build the oven and time to complete the charcoal production process. Mechanical drawings of the design detail the dimensions and aesthetic look of the oven.

3.0 Background

3.1 Location

The Mangrove Charcoal Sustainability Engineers for Sajalices (MCSES), traveled to the country of Panama for two weeks in August, 2010. The country of Panama is located near the equator and has a subtropical climate. The major language spoken by the roughly 3.4 million residents is Spanish. The team was able to travel to two different cities while in Panama: Sajalices and El Espavé. Each location provided information on the charcoal production process, to help further the research of the group. These locations can be viewed in Figure 1 below.



Figure 1: Locations visited in the country of Panama

Half of the time in Panama was spent in Sajalices, located roughly 70 kilometers from the City of Panama. This small town, consisting of approximately 1000 residents, was home to a small community of charcoal producers. This small group worked together to produce charcoal from mangrove trees and sold it to local grocery stores. The individuals formed an organization, the



United Defenders of the Sajalices Mangroves (DEUMSA), with the intent to protect the mangroves and develop a more sustainable process for charcoal production. The team spent the week with a host family in Sajalices. The host family, also members of DEUMSA, provided ample information on the subjects of charcoal production and forest sustainability.

While with the DEUMSA group, MCSES traveled to an island where charcoal was produced using traditional methods of stacking wood and open burning. This island was reached by hiking three miles from the host family's home and taking a boat ride through the mangrove forest. A view of the island, as seen approaching by boat, is shown in Image 1. A view from the island, into the mangrove forest, can be seen in Image 2.



Image 1: Approaching the island by boat



Image 2: A view of the mangrove forest from the island

The town of El Espavé also contained a group of individuals producing charcoal. El Espavé was located 10 kilometers from Sajalices. These individuals also used the traditional method of open burning. However, the people of El Espavé did not belong to an organized group with a mission to protect the mangrove forest. This visit provided additional information on the traditional burning method. The team was able to obtain data on the dimensions of the mounds, temperatures of burning, and smoke density readings.

An important aspect of charcoal production is the wood used to produce the charcoal, the mangrove wood. The mangrove forest is a crucial part of the coastal regions of not only Panama, but other countries near the Equator and in subtropical regions. The mangrove trees grow in the tidal zone on the coast, often completely submersed in water. The tree roots form a web design, interwoven within each other, which in turn helps to protect the coast from erosion. A photo of the mangrove trees can be viewed in Image 3. There are 70 different types of mangrove trees in the world and at least 12 grow in Panama. The most commonly used mangrove for charcoal production is the red mangrove. However, black and white mangroves have also been used. The red mangrove has been found to be the densest and burns the best. It also provides the best flavor when used for cooking purposes. The mangrove trees provide ample shelter and habitats for



many birds and fish. Fish use the mangroves as a place to spawn. Thus, while protecting the mangrove trees, fish and wildlife habitat will also improve. [1]



Image 3: The Mangrove forest at low tide

3.2 Organizations

Three different organizations assisted MCSES while working in Sajalices and the surrounding area. These three groups are the Panama Autoridad Nacional del Ambiente (ANAM), the United Nations Development Program (UNDP), and the United Defenders of the Sajalices Mangroves (DEUMSA). Each worked together to develop a better charcoal production method and decrease the negative environmental effects. Another key priority is sustaining and reforesting the mangrove forest.

Autoridad Nacional del Ambiente (ANAM) is an authority that regulates the harvesting of mangrove trees in order to protect and preserve the habitat that the mangroves present. ANAM also helps promote the sustainable development of local culture and environment and works with citizen participation. ANAM introduced a Japanese subterranean charcoal producing oven to the community, which has the potential to produce charcoal more efficiently while decreasing the environmental impact [2].

The United Nations (UN) is a global organization whose mission statement aims at facilitating cooperation in international law, economic development, social process and human rights. In



Panama, the United Nations Development Program (UNDP) works with ANAM to implement community based projects to improve quality of life and protect the environment. Many projects are facilitated by the UNDP through the Small Grants Program (SGP) of the Global Environment Facility (GEF). GEF was developed to help countries implement and finance projects that protect the global environment. The group of UNDP workers that MCSES collaborated with were focused on working with the community to preserve the mangrove ecosystem. They also helped the community members benefit from the ecosystem services through bee keeping and honey production, instead of being solely dependent on the mangrove trees. These representatives also helped MCSES gather information about the conservation and sustainable use of mangroves in Sajalices. [3]

The United Defenders of the Sajalices Mangroves (DEUMSA) is a community based organization supported by the UNDP. This organization was formed to help implement, manage and train the local workers on how to make charcoal from mangrove trees with minimal negative environmental impact. The organization consists of various Sajalices community members with a goal of helping to protect and preserve the mangrove forest and its ecosystem.

With these organizations' help, MCSES was able to gather information about the current traditional method of charcoal production, the newer Japanese style oven, the mangrove forest, and the needs of the local people of Sajalices. The information gathered led to the development of a detailed mission statement outlining criteria deemed most important. It also assisted in the overall design project completed by the team.

4.0 Technical Background

4.1 Pyrolysis

Charcoal is created through pyrolysis of biomass. Pyrolysis can be defined as the thermal decomposition of materials in an oxygen deficient environment [4], In essence, the pyrolysis process removes most of the chemical compositions within the wood product via heating until charcoal is left. This can sometimes be referred to as “carbonization” of the biomass.



The wood or biomass to be pyrolyzed can be heated from an alternate source to avoid burning the charcoal product. This is done by applying heat via an alternate fuel source to the pyrolysis area. The fuel, in this case, is scrap wood which can be burned directly in order to supply heat. The biomass is not directly burned and thus the system uses indirect heating. Once the system reaches the optimal temperature (which depends on composition of the substance), the pyrolysis process can begin.

During pyrolysis, volatile light molecular weight compounds are evolved as the wood decomposes. Some of these evolved gases are condensable at ambient temperatures. These volatile gases are the precursors to bio-oil, and if allowed to partially condense the liquid consists of Pyrolytic acid (wood vinegar) and wood tar. This particular process was utilized in Panama through the Japanese subterranean oven and where wood vinegar was collected. A chimney allows wood vinegar and wood tar to be condensed as pyrolysis byproducts. The chimney and collector are located away from the pyrolysis system, at a lower temperature, to condense the evolved gases into wood vinegar and tar.

4.2 Wood chemistry

Wood or biomass is typically comprised of oxygen enriched materials. This is due mainly to the fact that most organic wood or biomass absorbed air and retained oxygen for its own life-cycle. Along with the elemental oxygen being a part of the chemical make-up of most biomasses, in this case wood, there are many other major constituents, including cellulose (a polymer glucosan), hemicelluloses (which are also called polyose), lignin, organic extractives, and inorganic minerals [4].

Cellulose is what gives wood its strength, or toughness. It is usually insoluble and has a high molecular-weight. It is comprised of carbon, hydrogen, and oxygen atoms in a chain.

Hemicellulose helps to contribute to the increase in volatiles and decrease of tars that are by-products of the pyrolysis process. It also helps to contribute to the larger amounts of acetic acid



present in the volatiles and thus to the composition of the wood vinegar. Hemicellulose is also comprised mainly of carbon, hydrogen, and oxygen atoms. It also makes up most of the natural sugars within the biomass.

Lignin, during the pyrolysis process, typically produces large amounts of char, the carbon rich product. It is comprised primarily of carbon, hydrogen, and oxygen atoms.

The organic extractives that comprise biomass include different “fats, waxes, alkaloids, proteins, phenolics, simple sugars, pectins, mucilages, gums, resins, terpenes, starches, glycosides, saponins, and essential oils” [5]. The inorganic materials typically are comprised of mineral deposits found within the biomass.

5.0 Methods and Procedures

5.1 Overview

While in Panama, the MCSES team was able to collect information and data on the charcoal production methods of the traditional oven and Japanese oven. In El Espavé, we took average dimensions of the traditional mounds and developed a small map of the area. Temperature data was collected on mounds that had been burning for varying lengths of time. A smoke density chart was utilized to determine the amount of smoke released from a burning mound. With ANAM, the team was able to view a small scale Japanese oven and take approximate measurements. Each method of charcoal production was described in step-by-step detail to MCSES. The DEUMA group, ANAM and the UN workers, all proved to be excellent sources of information on the charcoal production and methods utilized. Photographic documentation also allowed the team to review the time spent in Panama.

Upon returning to the United States, MCSES used numerous tools in the design process. First the team conducted research on the charcoal production process, mangrove ecosystems, and alternative methods of charcoal production. The team contacted professors in the Forestry,



Mechanical Engineering, and Chemical Engineering departments. Computer programs such as UGNX, AutoCAD and Abaqus were also utilized.

5.2 Data Acquisition

MCSES gathered information to design a commercial scale oven well suited for the community members of Sajalices. The team conducted multiple on-site interviews to collect information about the mangrove forest, construction techniques, and characteristics of the traditional and Japanese oven, which were being used for the production of charcoal. While on the site, the team collected temperature readings, dimensions, and smoke density estimations for the traditional oven, as well as dimensional measurements of the Japanese oven. The team was equipped with the following testing equipment:

- Handheld thermocouple
- GPS
- Smoke density chart
- Measuring tape

Temperature readings were taken on various traditional ovens in El Espavé using the handheld thermocouple, the location of the oven was determined with the handheld GPS device. This process is shown in Image 4. The thermocouple was inserted into the traditional oven at three different positions, and temperature readings were collected for ovens at different stages of operation. The temperature readings and geographic locations are provided in Appendix A.





Image 4: Temperature reading measured with a hand held thermocouple for the traditional oven

Dimensions and smoke density of the traditional ovens in El Espavé were measured. The dimension of the oven was determined using a measuring tape as shown in Image 5. The circumference and height for the ovens were measured with a tape measure, shown in Image 5. These were taken at different stages of operation. In addition to the traditional oven, the dimensions of the Japanese oven were measured. The dimensions of the bricks used, the firebox, and the wood chamber were obtained using the measuring tape, as shown in Image 6.



Image 5: Measuring dimensions of the traditional oven with a tape measure



Image 6: Measuring dimensions of the Japanese oven with a tape measure

The smoke density of the traditional oven was measured using a smoke density chart as shown in Images 7 and 8. Two team members were positioned 10 feet away while one stood next to the oven with the smoke density chart. The members 10 feet away estimated the density of smoke leaving the oven system by comparing to it to a smoke density chart. This provided a rough estimate of the percentage of solid particulates in the escaping smoke for the traditional oven.

The smoke density result and the dimensions of the traditional and Japanese ovens are provided in Appendix A.



Image 7: Determining the smoke density of the traditional oven from ten feet away



Image 8: Determining the smoke density by holding the smoke density chart next to the Traditional Oven

In addition to the technical testing conducted, personal interviews concerning the traditional and Japanese ovens were conducted in the communities of Sajalices and El Espavé. The personal interviews were conducted with the assistance of the Autoridad Nacional del Ambiente (ANAM), the United Nations (UN), and the United Defenders of the Sajalices Mangroves (DEUMSA). The interview questions asked by MCSES were as follows:

1. What is the current operating procedure for manufacturing charcoal from red mangrove wood?
2. How do you collect the red mangrove wood used to produce the charcoal?
3. What is the current management plan for the mangrove forest?
4. How do you construct the traditional oven, and how long does it take?
5. What is the initial cost of the traditional and Japanese ovens?
6. What is the capacity, batch time and total volume of both the traditional and Japanese ovens?
7. What are the byproducts collected from the traditional and Japanese ovens?
8. What is the environmental impact of both the traditional and Japanese ovens?
9. Do you think there are any problems with your current oven system?
10. Are there any health issues you face when manufacturing the charcoal?
11. To whom is the charcoal being sold, and how much is one bag of charcoal sold for?
12. How much charcoal is contained in one bag?

The answers to these questions were recorded by MCSES and are provided in Appendix B. ANAM and DEUMSA also gave presentations to help MCSES gather information on how the mangrove trees are being used and preserved, as well as their environmental significance to the community. The current harvesting method is called 'ABC' tree harvesting and is described in section 5.2.1. Image 9 shows MCSES members at one of the presentations.





Image 9: MCSES members at a presentation given by United Nations (UN) on the mangrove forest

5.2.1 ABC Tree Harvesting

The idea behind 'ABC' tree harvesting in Sajalices is to ensure the re-growth of mangrove trees within the harvested area. The community has adopted this sustainable harvesting method due to the recognition that previous methods contributed to the deforestation of the red mangrove trees in the surrounding area. An incomplete harvesting was employed. Trees were cut and unharvested materials were left as ground litter, making re-growth difficult. This, coupled with a lack of replanting, contributed to deforestation.

'ABC' tree harvesting is a method of foresting based on three types of trees. The 'A' type of tree are 'mother trees', or 'seed trees'. These trees are spared due to their ability to produce seeds. Type 'A' type trees are typically 30+ years in age. Type 'B' describes the immature trees less than 10 years old. Type 'C' trees are the mature and sickly trees that can be harvested. The mature trees can be harvested anytime after growing ten years, as long as they are not "mother" trees. Sickly trees are those trees which fungus, disease, or improper growth has caused them not to develop fully. These unhealthy trees are harvested at any point once conditions are recognized.



When harvesting the mangrove wood for charcoal production, a 25 meter by 25 meter square plot is set as the standard collection area when considering sustainability. This prevents too many trees from being removed at a single time. Along with keeping the collection plot size standard, these harvesting methods also ensure that no debris or unused wood hinders reforestation.

6.0 Alternative Design Options

6.1 Japanese Oven (Subterranean Kiln)

The Japanese oven was introduced by ANAM. This oven was built of bricks with two in-ground chambers, one for the fuel wood and the other for the mangrove wood. This oven was designed as a household production oven. This oven is more efficient and better overall for the health of the families by use of the chimney to direct smoke away. Another advantage of the chimney is that it can collect a by-product called wood vinegar. This vinegar could be sold for profit, or used locally as a pesticide, once diluted with water. The Japanese oven can produce 114 pounds of charcoal for every 32 hours of operation, which is quite different from the traditional oven which produces 1,400 lbs in 6 days. The initial cost to build this Japanese style oven is \$533 dollars. ANAM estimated sizing up this design would create an oven with the capacity to commercially produce charcoal. This would place the estimated cost at \$2,000. Further alternatives are still worth exploring.[6] A sketch from ANAM can be seen in Figure 2 below [7].



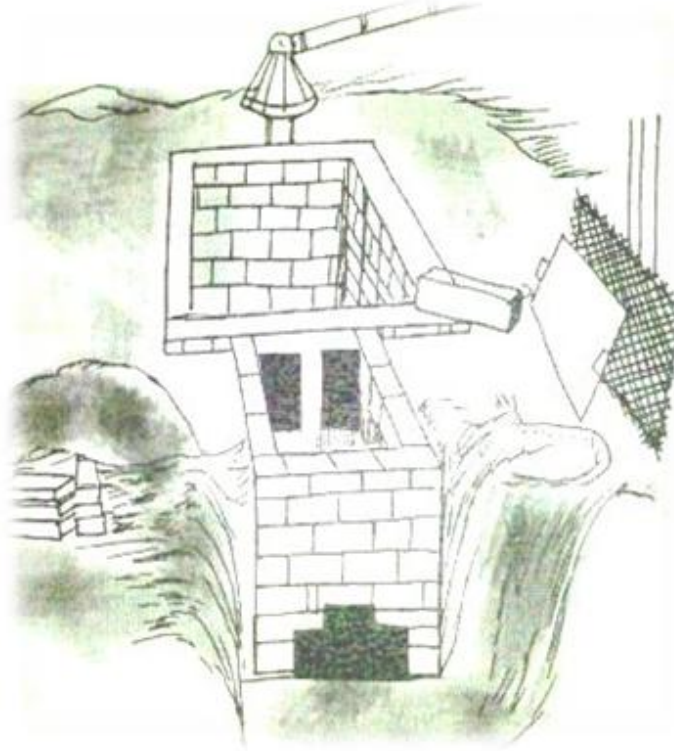

Figure 2: Japanese Oven (Subterranean Kiln) sketch [7]

6.2 Casamance Kiln

The Casamance kiln was identified as a larger option. Its pyrolysis chamber capacity may be 30-100 cubic meters, with a burn time closer to the traditional method of 6 days. The structure is also similar to the traditional method (stacking wood, covering it with grass and dirt and then lighting it), though it does have a chimney to help with health impacts and by-product collection. Though this method has a significantly lower initial cost, it does need to be rebuilt for every cycle. An example of the Casamance kiln can be seen below in Figure 3 [4],[8].

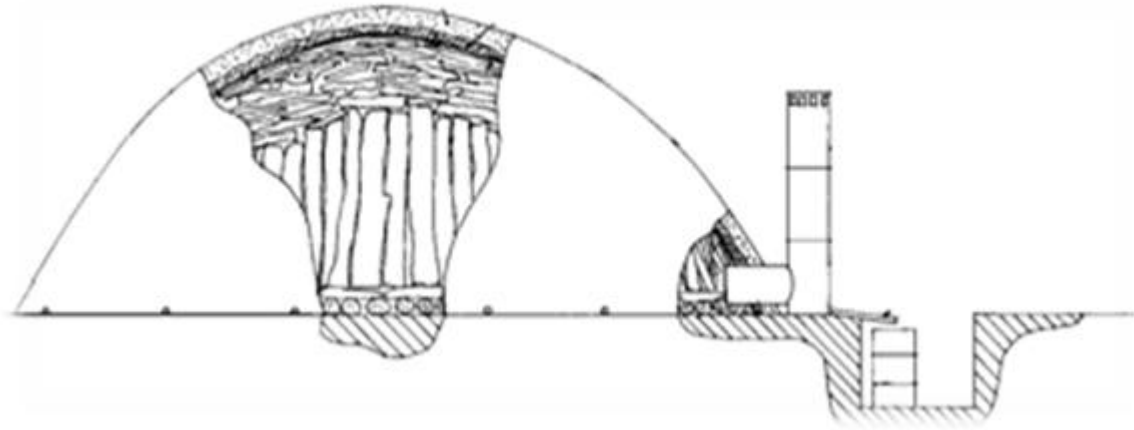

Figure 3: Casamance Kiln sketch [4],[8]

6.3 Brazilian Beehive

This method is a kiln that has an outer shell made from bricks. This beehive has a capacity of 45 cubic meters and contains many chimneys. Those chimneys help decrease smoke inhalation but do not provide a means for by-product collection. The batch time is 9 days, and the kiln has a life span around 6 years before it needs to be rebuilt, if maintained well. The beehive has an initial cost close to \$2,000, mainly due to the large amounts of earth that needs to be moved and the time it takes to build. Figure 4 shows an example sketch of the kiln [4].



Figure 4: Brazilian Beehive sketch [4]

6.4 Retort Kiln

The retort is another kiln method, built with bricks and mortar above the ground. This kiln has two chambers and a chimney for each chamber. The first chamber is where the fuel (fire wood) is burned, generating the heat needed to dry out and pyrolyze the wet mangrove wood. The second chamber contains the mangrove wood. In this method, heat transfer occurs by conduction through the brick wall that separates the chambers.

The retort system operates in two stages. The first stage is when the water and other volatiles escape from the wood and are collected between 81-150 degrees Centigrade. After this stage, the chimney for the pyrolysis chamber is closed, and the decomposition gasses are recycled to the fuel chamber to generate more heat.

Advantages to this method over the others are a shorter batch time, easier repair, reduced emissions, purer charcoal product, liquid by-product recovery, and sufficient capacity for commercial use. However, this design has a higher initial construction cost, and its implementation will be limited by the availability of resources in the area. An example sketch of the Retort Kiln is shown in Figure 5 [9,10].

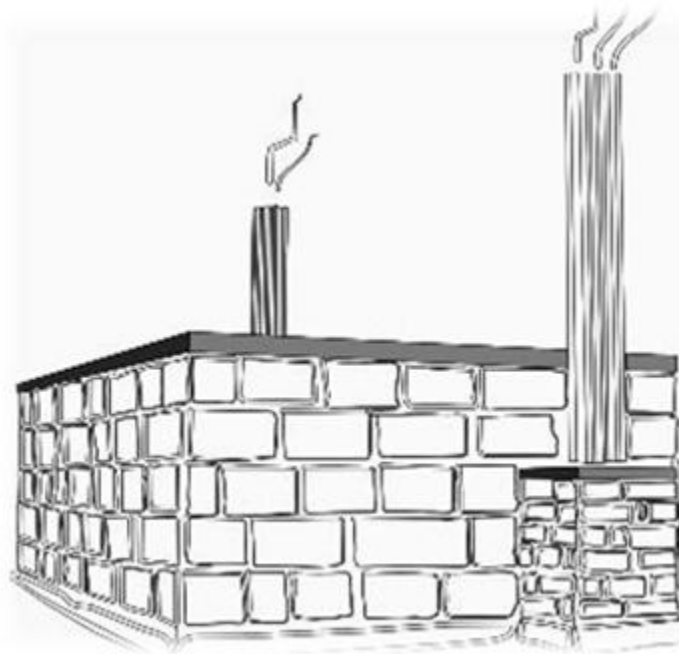

Figure 5: Adam Retort© Kiln Sketch [9,10]

7.0 Recommended Design

7.1 Objectives

The oven, or kiln, must have a sufficient volume in order to produce the quantity of charcoal specified per batch. Differences between the volume of green wood and charcoal must be accounted for. The density of green wood varies significantly with water content. Water weight can be 100% to 300% of the dry weight of the wood [6]. The variations in water weight must be taken into account when sizing the furnace to guarantee that even with maximum water content, the oven still produces the required quantity of charcoal.

Further requirements for design of a charcoal producing oven included the need for a sustainable construction and pyrolysis process. An overall short process time (less than one week) and commercial size was desired for a new charcoal oven.

More efficient burning and a reduction of harmful volatile emissions are also required. Since the carbonization of wood produces many harmful emissions detrimental to both the atmosphere as well as those working with the process. A more efficient burning will also reduce greenhouse gas emissions.

7.2 Overview

MCSES has designed a charcoal production method to satisfy the village/client's objectives. This design will hereafter be referred to as the MCSES retort.

The MCSES retort design uses similar construction materials as the Japanese oven. As shown in Figure 6, the overall design includes the box-shaped, brick/mortar construction. There are the three-piece metal plate cover, and two chimneys meant to control gaseous flow from the fuelbox and pyrolysis chambers to the atmosphere in the design. A metal collection tube located at the bottom of the pyrolysis chimney can also be seen. This tube is meant to collect volatile compounds in liquid forms. Figure 7 shows the same design without the three metal plate covers. This better portrays the location of the convection holes between the fuelbox and the



pyrolysis chamber, as well as general interior construction. Both of the drawings presented in Figures 6 and 7 were created utilizing Unigraphics NX.

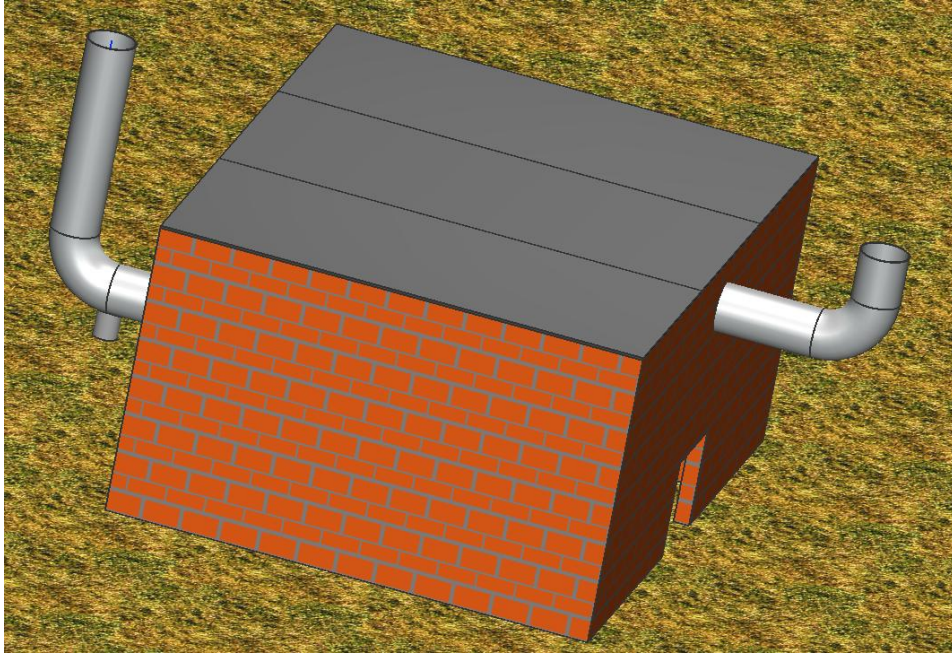

Figure 6: MCSES retort with metal lid and chimneys

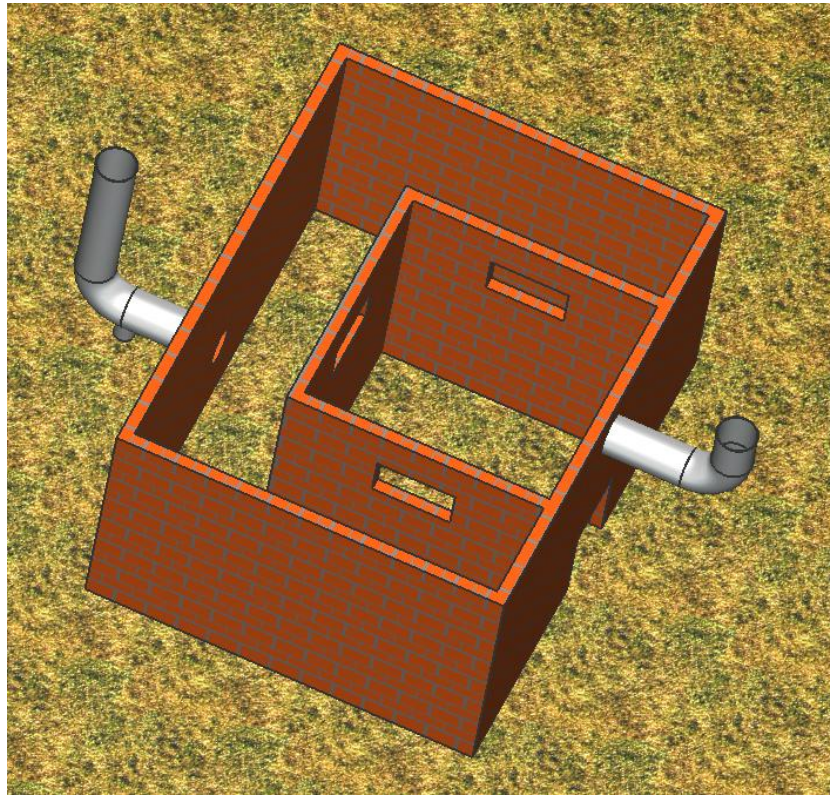

Figure 7: MCSES retort, interior shown

7.3 Unit Operations

The process flow diagram (PFD) for the MCSES Retort is included as Appendix D. The PFD breaks the charcoal process into three separate unit operations: the firebox, the pyrolysis chamber, and the chimney. The process has two distinct stages of operation, evaporation and pyrolysis.

7.3.1 Firebox

The firebox functions as a heater for the pyrolysis chamber. Heat is required to dry the mangrove wood, provide the activation energy for the pyrolysis reaction, and drive the reaction to the desired fixed carbon content. The quantity of fuelwood varies substantially based on the water content of the mangrove wood. The firebox has been sized large enough to load enough firewood to dry 300 wt% water and supply the necessary heat for the reaction. The fuelwood needs are based on the lower heating value of seasoned firewood and the duty (heat) required by



the pyrolysis chamber. The lower heating value of the fuelwood is taken to be 15.3 MMBTU/cord [9].

7.3.2 Pyrolysis Chamber

The pyrolysis chamber is the reaction vessel where mangrove wood is transformed into charcoal. This chamber was sized to accommodate the mangrove logs required to generate the desired charcoal yield of 40 bags (1400 pounds) per batch. The chamber was sized based on the volume of charcoal yield ratio of the Japanese subterranean kiln (0.53 cubic meters for 114 pounds of charcoal). The volume needed was calculated to be 6.508 cubic meters. This was based on the charcoal yields for hardwood species formed using similar processes reported [4]. Charcoal is assumed to be 33% of the weight of the oven dry mangrove wood. This means 4,444 pounds of dry mangrove wood is needed to obtain the desired charcoal yield.

7.3.3 Chimney

The chimney system functions as a separation column and a means of diffusing harmful emissions. Water and non-condensable vapor byproducts are vented while pyroligneous acid and wood tar condense and empty into a collection vessel. Condensed byproducts may later be separated and sold for additional profit.

7.4 Operation Stages

7.4.1 Evaporation

The first stage of the process is evaporation. Before pyrolysis can proceed, all water trapped within the wood must be driven off. Evaporation heat requirements were calculated by summing the latent and practical heat required, as in Equation 1. An ambient temperature of 80°F was assumed.

$$Q = mC_p\Delta T + m\Lambda \quad (1)$$

where Q is heat measured in BTU, m is mass in lb_m , C_p is the heat capacity in $BTU/lb_m^\circ F$, ΔT is change in temperature measured in $^\circ F$, and Λ is the latent heat in BTU/lb_m . Following Equation



1, the evaporation duty is 14.8 MMBTU at 300 wt% water. This was taken to be the maximum water weight encountered during operation, and this conservative estimate was used in sizing the firebox. Evaporation can be deemed complete when steam is no longer formed. The temperature inside the pyrolysis chamber will remain fixed at the boiling point of water during evaporation and rise thereafter. Evaporation occurs during the first two stages plotted in Figure 8. The operating conditions specified should be maintained over the course of the first four stages shown in Figure 8.

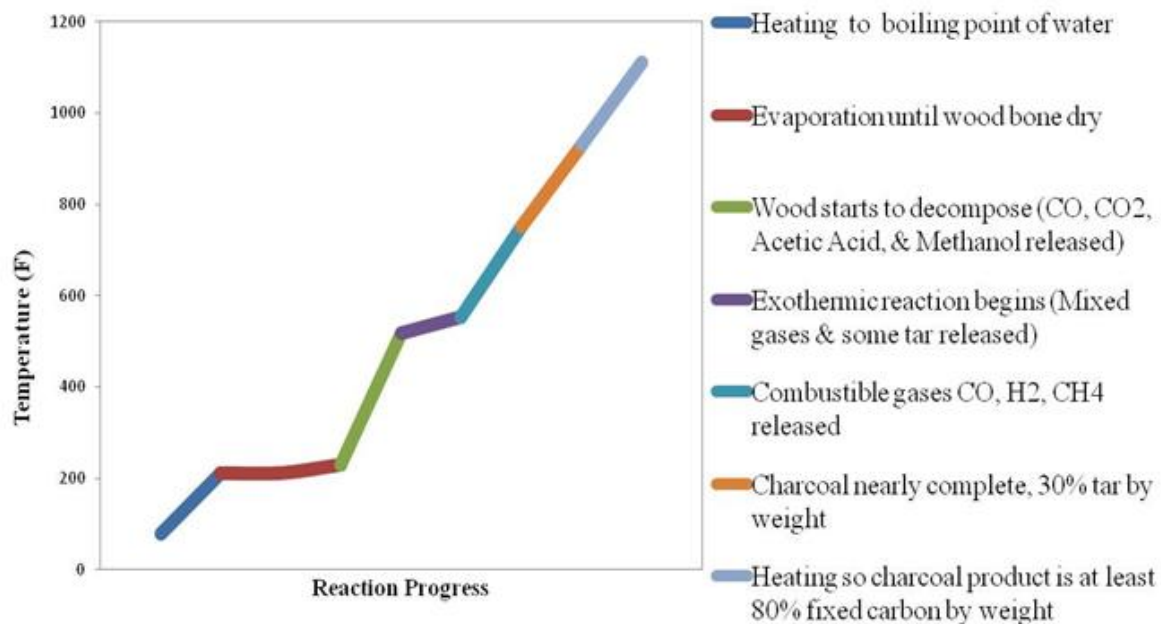
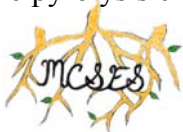

Figure 8: Stages of Pyrolysis, temperatures ranges taken from FAO Industrial Charcoal Making [11]

7.4.2 Pyrolysis

Pyrolysis will begin once the temperature nears 520°F. The wood decomposes exothermally, giving off gases as it does so. This exothermal process involves energy that is released by the forming of the chemical bonds in excess of the energy consumed by such bonds breaking. During this stage, the firebox chimney is opened, and the pyrolysis chimney flue and the flue between the chambers are closed. Due to the gas formation, positive pressure builds up within the pyrolysis chamber. Gases are directed into the firebox via an aperture in the bricks along the



bottom of the wall separating the chambers. Gases are driven by the pressure gradient into the firebox. Combustible gases are burned, adding their lower heating values to the energy supplied by the fuel wood and thus increasing the overall process efficiency.

7.5 Batch Time

Batch time consists of seven time periods, or stages, shown in Figure 8. The first stage of the batch time is spent driving off the high water content and then further heating the system in order to achieve the temperature at which pyrolysis begins. The time required to heat the wood from ambient temperature (80°F, 26.67°C) to the temperature at which liquid water would be driven off (212°F, 100°C) was found by using Figure 9 below along with Equations 2 through 6.

$$Y = \frac{T_1 - T}{T_1 - T_0} \quad (2)$$

where Y is a unit-less number used to find X from Figure 9 (temperatures in Fahrenheit of the system), T_1 is the temperature of the outer surface of the mangrove wood, T is the desired target temperature, and T_0 is the initial temperature at the core of the log. The value of Y is found to be 0.87. From Figure 9, X was found to be 0.063. From X , the time can be calculated from Equation 3,

$$X = \frac{\alpha * t}{x_1^2} \quad (3)$$

where X is a unit-less number found from α which is the thermal diffusivity of wood in Btu/ft*R-sec, t is the time in seconds, and x_1 is the radius of a log in meters. To find α , Equation 4 was used:

$$\alpha = \frac{k}{\rho * Cp} \quad (4)$$

where k is the thermal conductivity of the wood (Btu/ft-R), ρ is the density of the log in lbm/ft³, and Cp is the specific heat of the mangrove log in Btu/lbm-R. The value of α was found to be 8.008×10^{-9} ft²/sec. Rearranging Equation 3 for time gives Equation 5.

$$t = \frac{X * x_1^2}{\alpha} \quad (5)$$



The time for the process was thus found to be 1.16 hours. The time to heat the log to the pyrolysis temperature after the water is driven off was found in the same way, and was found to be 6.2 hours. The last three periods are shown to be linear and so they can be solved in one time step. The time to heat the log in these last steps to its final temperature to ensure full pyrolysis and an 80% carbon by weight (1100°F, 593°C) was found to be 24.2 hours.

To find the time required to drive off the water in the log, calculations were made in an idealistic manner, assuming the logs are smooth cylinders. Also assumed, all absorbed water and all volatiles leave with the liquid water. In order to calculate the time, the constant rate (R_c) at which wood can dry was calculated from Equation 6,

$$R_c = \frac{h \cdot \Delta T}{\lambda_w} \quad (6)$$

where h is the heat transfer coefficient in Btu/sec*ft²-R, ΔT is the temperature difference between the heated air and the temperature of the wood in Rankine (R), λ_w is the latent heat of water in Btu/lbm. The rate was then multiplied by the area of a log to get the constant drying rate. The rate was calculated and found to be 0.364 lbm/sec. Knowing the mass of water that needed to be driven off to be 13,333 pounds (6050 kg), this process would take 10.2 hours. Adding the time required for each process stage, the entire batch time is estimated to be 42 hours [12]. A table of nomenclature used can be found in Appendix E.



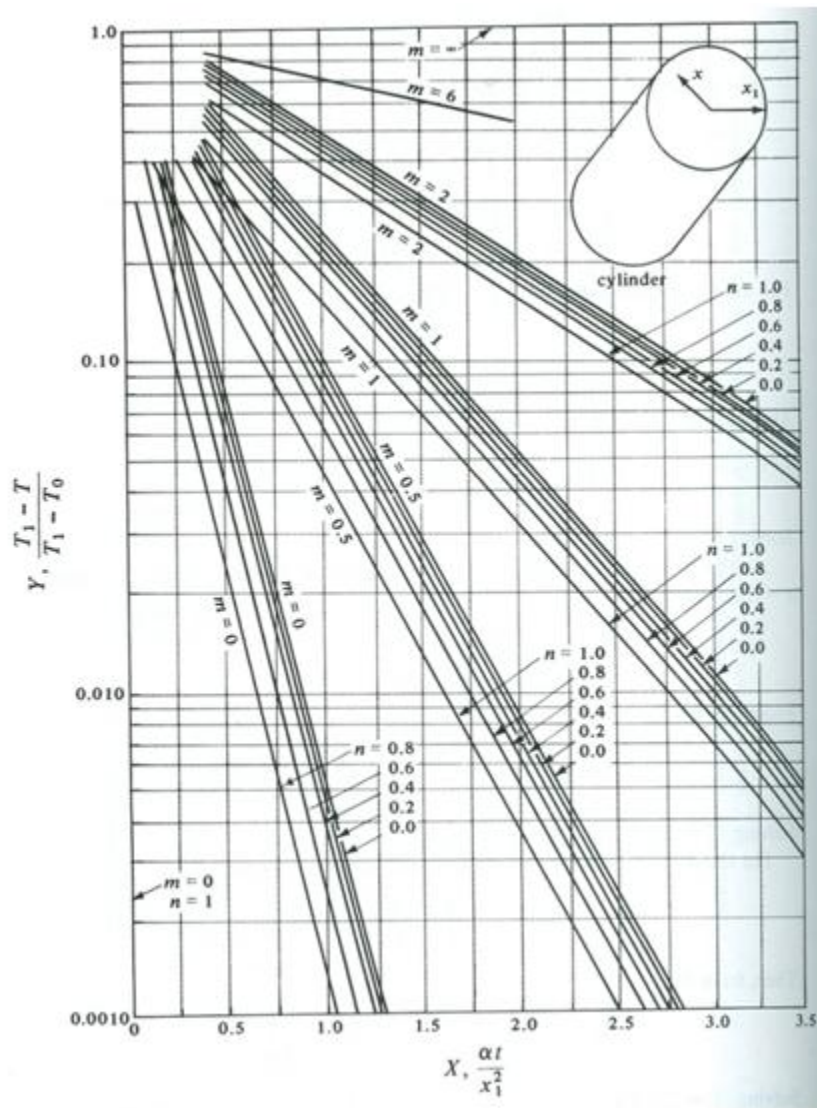

Figure 9: Unsteady-state heat conduction in a long cylinder [13]

7.6 Byproducts and Recycle

During the pyrolysis process, many different byproducts are formed. The MCSES retort design accounts for several byproducts, either for sale or for recycling within the charcoal production process. Only the liquid byproducts were considered marketable. Although there is value to the gases evolved in the process, there is no cost effective mechanism to capture and sell them. Reaction gases are, however, recycled as fuel into the firebox. This reduces the fuel wood consumption and thus the labor associated with acquiring the fuel wood. Reducing fuel wood consumption increases efficiency and reduces the overall emissions as well.



In order to determine the energy savings associated with recycling volatile gases, an accurate model of the pyrolysis reaction was needed. Shafizadeh [14] provided experimental yields for the pyrolysis of several experiments. Wood chemistry for red mangrove wood was not found, and so composition was as assumed to be that of Asiatic mangrove, as reported by Pettersen [15] and shown in Table 1. Wood chemistry data was only specified for hemicellulose, cellulose, and lignin, accounting for 94% of the mass. The pyrolysis reaction in the MCSES retort is based on Shafizadeh's study of cotton cellulose pyrolysis. Although the composition of cotton cellulose is not the same as mangrove wood, the cotton pyrolysis was conducted at similar conditions to the MCSES retort and was more thoroughly reported on compared to other studies found.

Table 1: Wood chemistry for Asiatic mangrove – taken as a substitute for red mangrove [15]

Hemicellulose	18%
Cellulose	54%
Lignin	22%
Total	94%
Total Carbohydrates	72%

Applying Shafizadeh's model to the MCSES retort should generate product yields as reported in Table 2. The retort can recover 22.62 MMBTU per batch if operated at 100% recycle. Although 100% recycle is not a practical operating condition, this presents a theoretical maximum energy recovery for the retort. Recycle should be adjusted based on the ability to sell byproducts. Byproduct recovery must be balanced with recycle. If byproducts cannot be sold or used locally, they should be recycled to minimize process waste, emissions, and fuel consumption.



Table 2: MCSES anticipated product yields and corresponding energy content taken at component lower heating value.

	% dry weight	lbm	MMBTU
Water	35%	1534	0.00
Acetic Acid	1%	62	0.36
Acetone	0%	3	0.04
Tar	4%	186	2.60
Other organic compounds*	5%	228	4.93
Carbon dioxide	10%	460	0.00
Carbon monoxide	4%	184	0.80
Methane	0%	12	0.26
Ethylene	0%	8	0.15
Total except charcoal	60%	2677	9.15
Charcoal	40%	1767	22.62

The liquid phase fraction for the expected components was plotted versus temperature and included as Figure 10. This was done to determine in which temperature range liquid byproduct recovery is possible. As shown in Figure 10, water has a much higher liquid fraction than the other components – as denoted with the secondary y axis. Adjusting temperature to minimize liquid water fraction would adversely affect byproduct recoveries. The temperature should be adjusted so no more water is condensed with the liquid byproducts than can be processed with existing equipment. It may be that large water recovery is desirable if the wood vinegar (acetic acid) is to be sold dilute. Condensed tar will be immiscible with liquid water and can be easily separated once the oil and water phases are allowed to partition.



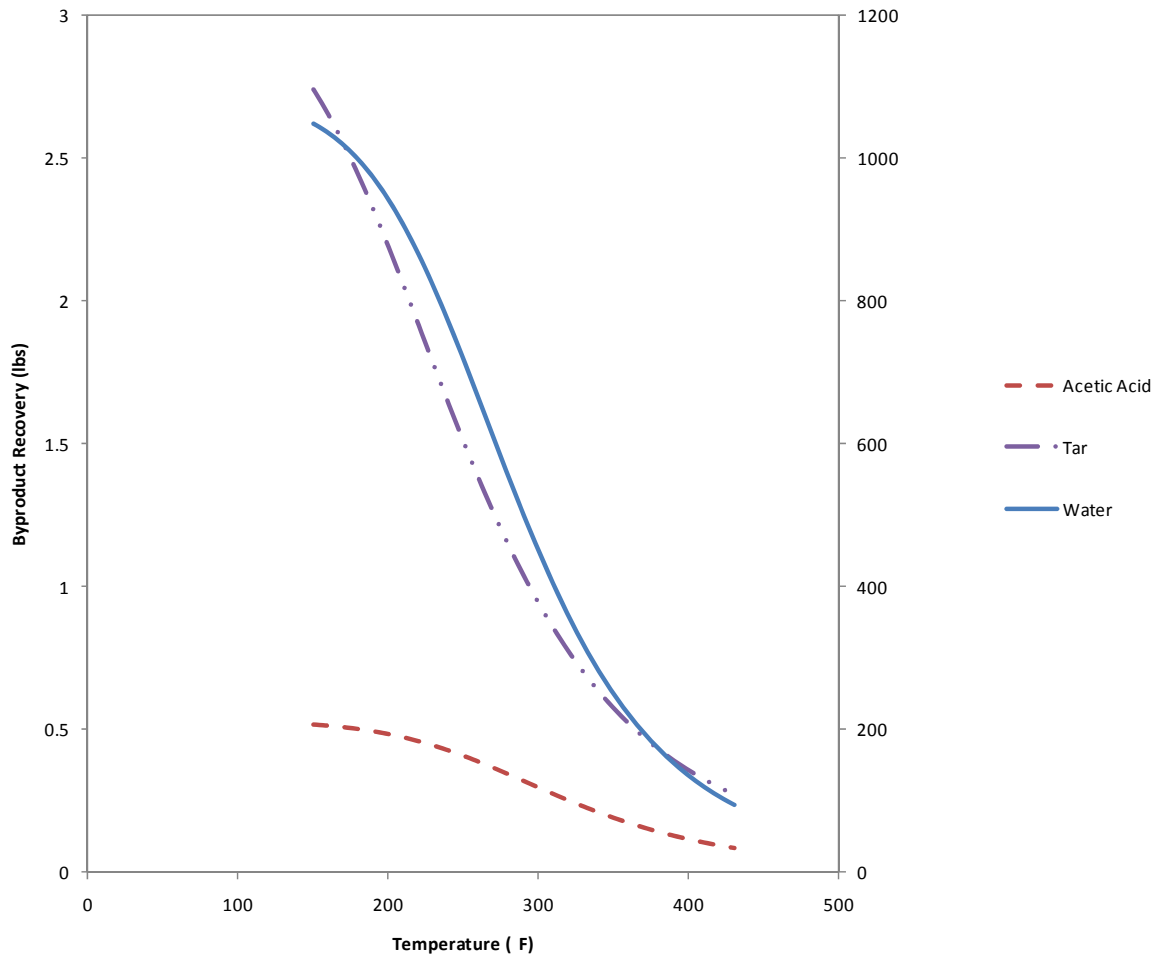

Figure 10: MCSES liquid byproduct recovery versus temperature – liquid water recovery is shown on the secondary axis

In order to estimate the maximum liquid byproduct recovery on the MCSES Retort, conditions were approximated to be 150°F. Yields expected at this condition are shown in Table 3. This table assumes operation at zero recycle, so product consumed during recycle is not accounted for. At maximum byproduct recovery, there will be no volatile gases recycled to the firebox and no added heating benefit will be observed. The retort could produce approximately 62 lbs of wood vinegar (mostly acetic acid) and 186 lbs of tar per batch. The design of the MCSES Retort is adaptable fit the production needs of the community.



Table 3: Liquid byproduct recovery in lbs at operating conditions: 150°F and zero recycle

Component	Recovery (lbm)
Water	422.6
Acetic Acid	0.7
Acetone	0.0
Tar	4.8
Other organic compounds	0.0
Carbon dioxide	0.1
Carbon monoxide	0.0
Methane	0.0
Ethylene	0.0
Total	428.3

7.7 Construction

Once a design was established, MCSES utilized information obtained while in Panama as well as outside sources in order to determine the availability of materials and a detailed construction schedule. While contact through organizations within Sajalices was minimal, an estimated construction run-time was determined. Through this construction schedule, a process schedule was able to be outlined in order to show the necessary steps, order of operation, and duration of each step necessary for charcoal production.

Appendix F outlines the construction schedule for the MCSES Retort, including details for specific task or activity, duration and corresponding work-days, pre-requisite activities, and other time considerations. With consideration of construction times observed in Panama, it was estimated that the total construction time for the MCSES Retort would be approximately 14 work days. Each work day was estimated at 8 hours per day. Specific construction activities include preparing the oven site, obtaining materials and tools, building the oven, and beginning the charcoal production process.

Appendix G outlines the process schedule determined for the production of charcoal through the MCSES Retort. This process schedule included not only the pyrolysis time but also the time needed to collect fuel and mangrove wood, replant trees in harvested area, place wood in each chamber, manage the pyrolysis process, collect charcoal and by-products, and clean the entire



system. The operation time was estimated using the same criteria and assumptions as the construction operation. It was determined through these estimations that the process would take 125 hours (5.21 days) and a total of 12.75 person-days.

7.8 Cost Estimate

Information was gathered regarding the cost of materials used for the Japanese oven design while in Panama. The materials required for the MCSSES design are similar to those used for the Japanese oven, just in different quantities. Thus, the material costs for this project were based off the costs obtained for the materials used in the Japanese oven [7]. The project estimate is about 20% higher than the projected value of \$2,000, which was estimated by ANAM. This estimate is a based on scaling up the Japanese oven design costs, including the materials and tools that will be needed for the oven construction. All of the construction can be done by community members, as they are knowledgeable in construction work.

Table 4: Total construction cost estimate of MCSSES retort

	Items	Cost
Materials	Fire brick	\$1,466
	Metal plate	\$600
	Screen	\$208
	Bamboo	\$1
	Chimney tube	\$3
	Bell cone	\$96
	Wire	\$1
	Total:	\$2,375
Tools	Shovels	\$12
	Measuring tape	\$4
	Bucket/ wheelbarrow	\$40
	Trowels	\$6
	Total:	\$61

TOTAL COST: \$2,436

As shows in Table 5 below, the labor cost was estimated based on the total amount of time spent by the workers on wood harvesting, setting up the retort, and packaging the charcoal. It was

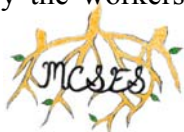

assumed that for each oven system there were four workers, each working six days per week and 10 hours per day and receiving a minimum wage of \$1.0 per hour [16]. These assumptions were based on the information gathered while in Panama. The annual cost of fuel wood was estimated based on the assumption of the worker’s using a boat to transport their tools to the site, harvesting the wood, and transporting the charcoal from the site to the market. The total cost was calculated based on the total fuel used per year, assuming a 15-horse power, 2-stroke Honda boat motor using gasoline at the price of \$2.76 per gallon [17],[18].

Table 5: Labor analysis for MCSSES retort

Components	Amount
Total bags	40
Process Cycle (day)	5.75
Total Labor (hr/week)	120
Service Factor	0.8
Operation (week/c-yr)	42
Production (bags/c-yr)	6720
Total Charcoal (lb/c-year)	235200
Total labor hours (hr/c-yr)	20160
Minimum wage (\$/hr)	\$1.00
\$/week	120.00
Total (\$/c-year):	\$4,992

The annual operating cost to produce 235,200 pounds of charcoal per year at a batch time of 42 hours was estimated based on the annual cost of fuel wood, labor, and the cost of transporting both the wood to the retort kiln site and the charcoal product to the market. It was found that the total annual operating expense of the project is \$11,278. After the estimate total was calculated, a ten percent contingency was added to the total to allow for any estimation error and yield a total of \$12,406 per year. The total revenue which can be generated from this recommended MCSSES design is \$16,800, with a net profit of \$4,394 per year. The profit analysis can be found in Table 6.



Table 6: Annual profit analysis of MCSSES retort

	Components	Amount
Cost (\$/c-year)	Fuel wood	\$0
	Labor	\$4,992
	Boat & tool motor fuel	\$5,286
	Transport to market	\$1,000
	Total (\$/c-year):	\$11,278
Revenue	Bags produced per batch	40
	Weight of bag (lbs)	35
	Batch time (hrs)	42
	Service factor	0.8
	Operation (wks)	42
	Bags produced per year	6720
	Charcoal per yr (lb/c-year)	235200
	Cost per bag (\$/bag)	\$2.50
	Total (\$/c-year):	\$16,800
	Contingency costs (at 10%)	\$1,128
	NET PROFIT (per yr):	\$4,394

8.0 Conclusion

Using information gathered in Panama, from the literature, and from professors at Michigan Tech, the MCSSES team performed energy balance calculations, determined sizing specifications, developed cost estimates, and generated construction and process schedules for the MCSSES Retort kiln. Although significant data uncertainties and assumptions remain, it can be concluded that the recommended design is expected to meet the desired criteria of efficiency, affordability, worker safety, and environmental protection, as summarized in Table 7. The MCSSES retort should be affordable, at \$2,440, and with a payback period of 6 months, along with the current financial support from GEF and the UNDP. The efficiency is increased by the two separate chambers; the mangrove wood need not be used as fuel. Worker and environmental safety will be improved by the use of a chimney to direct the smoke particulates away from workers



(avoiding lung irritation), and sustainability will be achieved by continued practice of the ABC harvesting and reforestation methods.

Table 7: Overview of system performance and solutions to meet the specified criteria for MCSES retort

Criteria	Solution
1. System for commercial production of charcoal	✓ MCSES Design
2. Durable	✓ Fire bricks, square design, easily repairable
3. Low cost	✓ \$2,436 (6 mo. payback period)
4. High efficiency	✓ 235200 lbs per year
5. Reduce harmful emissions	✓ Recycle process
6. Protect health of workers	✓ Chimney to direct smoke, no exposed flame
7. Protect and maintain the mangroves	✓ Continue ABC harvesting and replant

9.0 Recommendations

In correspondence with the MCSES Design, further recommendations are needed in order to produce the best results possible. An overhead shelter should be built in order to protect the retort from getting wet and ruining the seal of the lid during the process. Water should not get into the system not only could it hinder the process but it will deteriorate the final purity of the charcoal (80 % carbon by weight). To retain the heat inside the system, building the retort partially in the ground, or mounding dirt around the sides, should be considered.

To maximize the output of the retort, all ashes and cisco should be removed after each batch to maximize capacity. If possible, the mangrove wood should be stored under a shelter and allowed to partially dry. Reducing the water content of the mangrove wood would dramatically reduce the batch process time and fuel wood requirements. In addition, given all of the uncertain data used in this design, it is strongly recommended that experimental trials be performed. A pilot (somewhat smaller) plant should be tested before full-scale construction takes place at one or more locations. Frequent contact and communication between the collaborating groups should remain a priority in implementation of this design and in any future design projects.



10.0 Acknowledgements

With our design project, many “dead ends” were overcome with assistance from the following individuals:

Felipa Guardia and her family: she was our amazing host mother, and her family was all very hospitable.

Members of DEUMSA: they brought us around the communities’ charcoal production site and did their best to show us how the current system is running, along with the lifestyle of the community.

Members of the United Nations: they helped so much with coming up with the project they wanted us to complete, along with helping us get to and from the City of Knowledge to Sajalices. These members were our ambassadors throughout the whole project.

Dr. David Watkins: he was our main advisor for this design project, and helped provide fresh ideas, and constructive criticism from the beginning to the end.

Kelli Whelan, she was our mentor and as such she played the most valuable position of our translator. We would have not gotten by without her.

Mike Drewer: he was another faculty mentor on the trip out to Panama and helped us learn more about the area around the canal.

Many professors and faculty from the Chemical Engineering, Mechanical Engineering, and Forestry Sciences departments: All of these members gave guidance, references, equations, and advise for our project. Without these members, many of our “dead ends” would have taken up more of our time.

Without the help of these individuals, this project would not have been possible. We are all thankful for their ideas, support, and knowledge, and we hope to carry what we have learned into our future professional lives.



11.0 References

- [1] Lozano, Lourdes E. *Manglares Para La Vida*. Print.
- [2] *Bienvenidos a La Web De La ANAM*. Web. 25 Aug. 2010. <<http://www.anam.gob.pa/>>.
- [3] "Welcome to the United Nations." *Welcome to the United Nations: It's Your World*. 2010. Web. 25 Aug. 2010. <<http://www.un.org/en/>>.
- [4] FAO Forestry Department, "Simple technologies for charcoal making". *FAO: FAO Home*. Web. 25 Aug. 2010. <<http://www.fao.org/docrep/x5328e/x5328e00.htm>>.
- [5] Mohan, Dinesh, Pittman, Charles U., and Steele, Philip H. "Pyrolysis of Wood/Biomass for Bio-oil: A Critical Review." *Energy and Fuels*. (2006).
- [6] Shimada. "Hacia Una Cultura Ambientalmente Sostenible En El Arco Seco." ANAM, El Cacao. Aug. 2010. Lecture.
- [7] Vega, Luis, and Kenichi Takano. *Produccion De Carbon Y Vinagre De Carbon*. La Chorrera. (2005). Print.
- [8] "Casamance Kiln | BioEnergy Lists: BioChar (or Terra Preta)." BioEnergy Lists: BioChar (or Terra Preta) | Information on the Intentional Use of BioChar (charcoal from Biomass) to Improve Soils. 2009. Web. 25 Aug. 2010. <<http://terrapreta.bioenergylists.org/casamancekiln>>.
- [9] Adam, J.C. "Improved and more Environmentally Friendly Charcoal Production System Using a Low-cost Retort Kiln (ECO-Charcoal)." *ISESCO Science and Technology Vision*. (2008)
- [10] "ICPS / Retort Kiln Low-cost - Improved Charcoal Production System, Retort Kiln." *Home - Improved Charcoal Production System, Retort Kiln*. Web. 2010. <<http://www.biocoal.org/3.html>>.
- [11] FAO Forestry Department, "Industrial charcoal making". Web. 25 Aug. 2010. <<http://www.fao.org/docrep/x5555e/x5555e00.htm>>
- [12] Chunwarin, Wiraj, Mahitthikul, Chalerm, and Panichsuko, Somchai. "Production of charcoal and Charcoal Briquette from Mangrove Timbers."
- [13] Geankoplis, Christie J. "Chapter 5.3D Unsteady-State Conduction in a Long Cylinder." *Transport Processes and Separation Process Principles: (includes Unit Operations)*. 4th ed. Upper Saddle River, NJ: Prentice Hall Professional Technical Reference. (2003): 369-70. Print.
- [14] Shafizadeh, F. "Pyrolysis and Combustion of Cellulosic Materials." *Advances in Carbohydrate Chemistry* 23 (1968): 419-74.
- [15] Pettersen, Roger C. "The Chemical Composition of Wood." *The Chemistry of Solid Wood: Advances in Chemistry Series* 207 (1984): 57-126
- [16] "Panama Labor Law, Employment in Panama." *Panama Business & Travel, Home Page*. Mon. 29 Oct. 2010. <<http://www.panamabusinessandtravel.com/Panama-Labor-Law.php>>.
- [17] "Panama City Gas Prices - Find the Lowest Gas Prices in Panama City, Florida." *Florida Gas Prices - Find Cheap Gas Prices in Florida*. Mon. 29 Oct. 2010. <http://www.floridastategasprices.com/Panama_City/index.aspx>.
- [18] "Tohatsu Outboards - Fuel Consumption Chart." *Tohatsu Outboards - Discount Marine Outboards by Tohatsu*. Mon. 29 Oct. 2010. <<http://www.tohatsu-outboards.com/fuel-consumption.htm>>.



Antal Jr., Michael Jerry and Gronli, Morten. "The Art, Science, and Technology of Charcoal Production." *American Chemical Society*. (2003)

Briggs, S. V. "Estimates of Biomass in a Temperate Mangrove Community." *Australian Journal of Ecology*, 2.3. (1977). Print.

Chapter 7 Units and Measurements. Copyright © 2004. ASA-CSSA-SSSA, 5585 Guilford Rd., Madison, WI 53711, USA. Publications Handbook and Style Manual.

Christensen, Bo. "Biomass and Primary Production of *Rhizophora Apiculata* BL. in a Mangrove in Southern Thailand." *Aquatic Botany* 4 (1978). Print.

Dahdouh-Guebas, F., Mathenge, C., Kairo, J.G., and Koedam, N. "Utilization of Mangrove Wood Products around Mida Greek (Kenya) amongst Subsistence and Commercial Users." *The New York Botanical Garden*. (2000)

Duke, Norman C. and Allen, James A. "Rhizophora mangle, R. samoensis, R. racemosa, R. x harrisonii (Atlantic-East Pacific red mangrove)." *Species Profiles for Pacific Island Agroforestry*. (2006)

Goyal, Hari. "Properties of Wood (for Papermaking)." *Pulp & Paper Resources on the Web*. Web. 23 Oct. 2010. <<http://www.paperonweb.com/wood.htm>>.

Jackson, Michael A., Compton, David L., Boateng, Akwasi A. "Screening heterogeneous catalysts for the pyrolysis of lignin." *Journal of Analytical and Applied Pyrolysis*. (2009)

Kammen, Daniel M., and Debra J. Lew. *Review of Technologies for the Production and Use of Charcoal*. Tech. Golden, CO: National Renewable Energy Laboratory. (2005). Print.

Khoo, Hsien H., and Reginald BH Tan. *Report for ASEAN Biomass Meeting*. Tech. Singapore: National University of Singapore. Print.

Kimaryo, B.T. and Ngereza, K.I. "Charcoal Production in Tanzania Using Improved Traditional Earth Kilns." *IDRC Communications Division*. (1989)

Kridiborworn, Patanan, Chidthaisong, Amnat, Towprayoon, Sirintornthep, and Tripetchkul, Sudarat. "Mitigating greenhouse gas emissions through mangrove plantation and charcoal production." *The Joint Graduate School of Energy and Environment, King Mongkut University of Technology Thonburi (KMUTT), Bangkok 10140 and School of Bio-resources and Technology, King Mongkut University of Technology Thonburi, Bangkok 10150*. (2009)

Lacerda, L. D. "Conservation and Sustainable Utilization of Mangrove Forest in Latin America and Africa Regions." *International Society of Mangrove Ecosystems* 1. (N.D.) Print.

Mallory, Richard T. "Bricklaying for the Do-It- Yourselfer." *Mother Earth News*. Web. Date Accessed. <www.motherearthnews.com>.



Mitchell, R. L., and Geo J. Ritter. "Composition of Hemicellulose Isolated from Maple Wood." *Journal of American Chemical Society* 62 (1940): 1958-959. Web. 23 Oct. 2010. <<http://pubs.acs.org/doi/pdf/10.1021/ja01865a016>>.

Prasertimartati, B., H. S. Tai, N. Santoso, R. Mustikasari, and C. Syah. "Mangrove Forest and Charcoal Production: Case of Batu Ampar, West Kalimantan." *IASC 2008 Global Conference* (2008): 1-18. Web.

Ribot, Jesse C. "Theorizing Access: Forest Profits along Senegal's Charcoal Commodity Chain." *Development and Change*. (1998)

Shimada. "Produccion De Carbon Y Vinagre De Carbon." ANAM, El Cacao. Aug. 2010. Lecture.

"The Zambia Charcoal Industry by SH Hibajehe." *HEDON Household Energy Network*. Web. Aug. 7, 2010. <<http://www.hedon.info/TheZambiaCharcoalIndustry>>.

"Thermal Conductivity." *Thermal Conductivity of Some Common Materials*. The Engineering ToolBox. Web. 19 Nov. 2010. <http://www.engineeringtoolbox.com/thermal-conductivity-d_429.html>.[2].

Untawale, A.G. "Management of Mangroves for Energy Needs." *An Anthology of Indian Mangroves*. (1998)

Uvarov, Alexei V. "Effects of Smoke Emissions from a Charcoal Kiln on the Functioning of Forest Soil Systems: a Microcosm Study." *Environmental Monitoring and Assessment* (1998): 337-57. Print.

Weinstock, Joseph A. "Rhizophora Mangrove Agroforestry." *The New York Botanical Garden*. (1994)

Wilkinson, Martin A. "Thermal Properties of Building Materials." *Student Subdomain for University of Bath*. University of Bath. Web. 23 Oct. 2010. <<http://people.bath.ac.uk/absmaw/BEnv1/BE1.htm>>.



Appendix A: Acquired Data**Table A1:** Temperature data for traditional ovens in El Espavé

Day	Trial 1 (°C)	Trial 2 (°C)	Trial 3 (°C)
1	29	31	31
1	60	63	73
1	80	76	82
2	N/A	N/A	N/A
3	115	139	88
4	330	331	360
5	N/A	N/A	N/A
6	N/A	N/A	N/A

Table A2: Locations of the traditional ovens located in El Espavé

Day	N (° ' ")	W (° ' ")
1	8 39 30.9	79 52 6.6
1	8 39 31	79 52 5.9
1	8 39 31.2	79 52 5.8
2	N/A	N/A
3	8 39 30.7	79 52 6.4
4	8 39 31.8	79 52 6.2
5	N/A	N/A
6	N/A	N/A

Dimension and smoke density of the traditional ovens in El Espavé

All of the traditional furnaces were built to a height of 6 ± 0.8 feet with a circumference of 46 ± 0.8 feet, but by Day 4 they had shrunk to a height of 5 feet and had expanded to a circumference of 48 ± 1.66 feet. The system has a 4% smoke density.



El Espavé
Traditional Oven Information

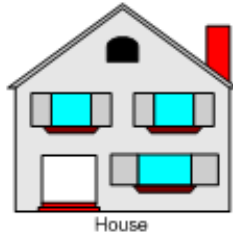

Process Day: 4
Height: 5'
Circumference: 48' +/- 20"



Temperatures (°C):
330
331
360

Process Day: 1



Temperatures (°C):
29
31
31

Process Day: 3



Temperatures (°C):
115
139
88



Process Day: <1
Height: 6' +/- 10"
Circumference: 46' +/- 10"



Temperatures (°C):
60
63
73

Process Day: 1
Hypotenuse: 128"



Temperatures (°C):
80
76
82

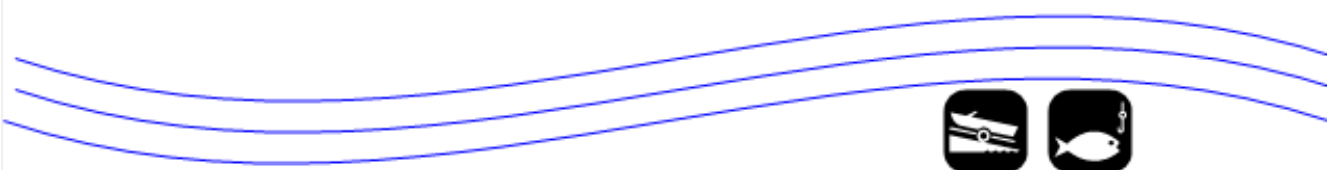

Dimension of the Japanese oven

The Japanese oven was built to a height of 0.80 meter using a fire brick with a size of 7.5" x 2.5" x 3". The design consists of a firebox and a wood chamber. The fire box and wood chamber have total dimensions of 0.40" x 0.50" x 0.80" and 0.75" x 0.88" x 0.80", respectively.



Appendix B: Community Interview Results

During the interviews conducted in the communities of Sajalices, El Espavé, and the island, Isleta, the team found out that the traditional oven is being utilized to produce charcoal in the community of El Espavé, and the island, Isleta. Workers from Sajalices traveled to the island, Isleta by walking three miles from Sajalices and then taking a short boat ride through the mangrove forest while the workers El Espavé traveled by boat to the mangrove forest to harvested red mangrove wood. The wood is then transported to the manufacture site by boat where the material is utilized in the construction process of the traditional oven and manufacturing the charcoal. The traditional oven construction itself consisted of the red mangrove wood harvested, straw or brush gathered in the area, saw dust particles, and soil laced with past oven by-product particulates. The wood utilized to produce the charcoal consisted of red mangrove wood primarily because of its high density and ideal burn quality. This type of tree was in the most abundance in the surrounding area and could be harvested the easiest. These forests of trees are located along rivers and larger bodies of water. The straw or brush was also collected in surrounding areas by harvesting in small dense locations closer to land. This material would be allowed to dry in order to not hinder the production of the charcoal. The soil-particulate mixture was ideal for use as an oven cover in order to maintain proper temperature control for the system. The tools and equipment utilized in order to help construction of the mound included chainsaws for wood collection, small boats to navigate and transport wood and materials, shovels in order to collect and dispense soil and other materials, and a “Ma-cher-o” used to light the mounds. The “Ma-cher-o” device was comprised of a long stick with a kerosene soaked cloth around one end.

The process through which the oven was constructed involved many steps. Initially, the mangrove wood was piled and formed into a conical dome-shape, with smaller pieces of wood in the center of the formation and larger pieces utilized as the structure expanded outward. This process was conducted in a very particular and careful manner, as was explained by one of the groups, so that as the wood burned, the mound would retain its shape and not collapse under its own weight. In essence, if the wood was not stacked to a particular height and shape, there



would be a grave flaw in the production of the charcoal. Smaller pieces of wood were also positioned around the perimeter of the mound toward the bottom in order to allow for a vent of air for the initial stage of the burning process. The area of the oven was also given in a pre-determined plot of land whose circular shape was used a gage for the overall size. This plot of land is portrayed in Image B1.



Image B1: Plot Area

Once the wood was stacked properly, the dried brush or straw was added in order to cover any larger holes in which excessive amounts of smoke would leave or excessive amounts of air would enter. This wood stack can be seen in Image B2, along with the beginning stages of the brush layer on the top of the mound.



Image B2: Wood Mound Construction

Dried brush eventually covered the entirety of the wood mound. Once this composition of dried brush was applied, a layer of soil laced with crushed charcoal by-product produced from previous burns was then placed over that layer. These two layers were placed over the entirety of the mound above the designated vent opening. This vent design, as well as the final constructed traditional mound oven, is portrayed in Image B3.



Image B3: Final Mound Construction

The primary reasoning for this vented opening was to allow air to be introduced to the burn process in the beginning stages in order to allow for an even burn. Once the mound was constructed properly, the “Ma-cher-o” was lit and introduced into a small opening at the bottom of the mound that leads into the center of the oven. The oven was then left to burn for six days, whereupon the charcoal product was produced. During this six-day period, the opening at the bottom of the mound, that was formed initially, was covered and water was added to douse any large fires that formed inside the oven. Excessive fire would reduce the quantity and quality of the charcoal product.

The traditional mound is capable of producing 2800 pounds of charcoal every 6 days. The system produces a total of 80 bags of charcoal where one bag contained 35 pounds of charcoal which is being sold at a price of \$2.50 per bag. Along with the charcoal product, useful by-products include sisco and ash particulates. The charcoal produced can vary in size but must be large enough to be utilized in household cooking appliances as well as larger systems. The charcoal produced can be viewed in Image B4.



Image B4: Charcoal Product

The sisco is comprised of smaller charcoal pieces that are not able to be harvested among the larger ones and thus can be used for fertilization of gardens or crops. This sisco is typically not harvested for commercial use but instead for personal house-hold use. An example of the sisco produced is seen in Image B5.



Image B5: Sisco by-product

The ash particulates are typically combined with the surrounding soil, as well as the soil used to cover the oven.. While vinegar is another by-product of this process, it is not able to be harvested due to the lack of a collection device or system such as a chimney.

Of the overall impacts that this system had on the area, the environmental and human health impacts were most prevalent. The negative environmental impacts that were apparent were centralized around the realization that deforestation was becoming an increasing problem. Deforestation had been the result of improperly harvesting the red mangrove wood through a “slash-and-burn” method of collection. With this method, if the wood is improperly harvested, and smaller pieces of uncollected wood are left on the ground, the ability of the trees to reforest naturally would be restricted. This method would also not allow for the observance of trees that should not be harvested due to immaturity or ability to produce seedlings. Another large environmental impact this process has is its effects on other plant and animal life in the area. Removing the trees would potentially affect habitats for indigenous animal and plant life. This

slash-and-burn method would also affect the ground run-off in that area and adversely affect river life. Along with the negative environmental impacts, human health was also a primary concern. The primary mortality statistic that was found for workers involved in this charcoal production method was respiratory deterioration. This is very likely linked to the the large quantities of smoke inhalation during the six-day burn process.

In comparison of the Japanese oven to traditional oven, the Japanese oven was designed as a personal production oven, intended for a household production scale, while the traditional oven is used for a commercialize scale. The Japanese oven was built of bricks, with a chimney and two chambers, one for the fuel wood and the other for the mangrove wood. The fuel wood chamber utilizes a different type of wood meant to fuel the carbonization process but not meant to be pyrolyzied into charcoal. This allows for a greater flexibility of operation, since more easily obtainable scrap wood can be burned as fuel. In the wood chamber, red mangrove wood is loaded into the chamber and later heated with fire through convection from the fuel wood chamber. Once the burn process is complete for the Japanese oven, products and by-products are collected, charcoal, ash, sisco and wood vinegar. The wood vinegar is mainly viewed as a by-product and is collected through the chimney (Image B6). This vinegar could be sold for profit, and it may be used is a pesticide once diluted with water. The Japanese oven is capable of producing 114 pounds of charcoal every 32 hours. The system produces a total of 4 bags of charcoal, each containing 28.5 pounds of charcoal being sold at a price of \$2.50 per bag.



Image B6: The chimney of the Japanese oven

Appendix C: MCSES Design Plan View (All dimensions in meters)

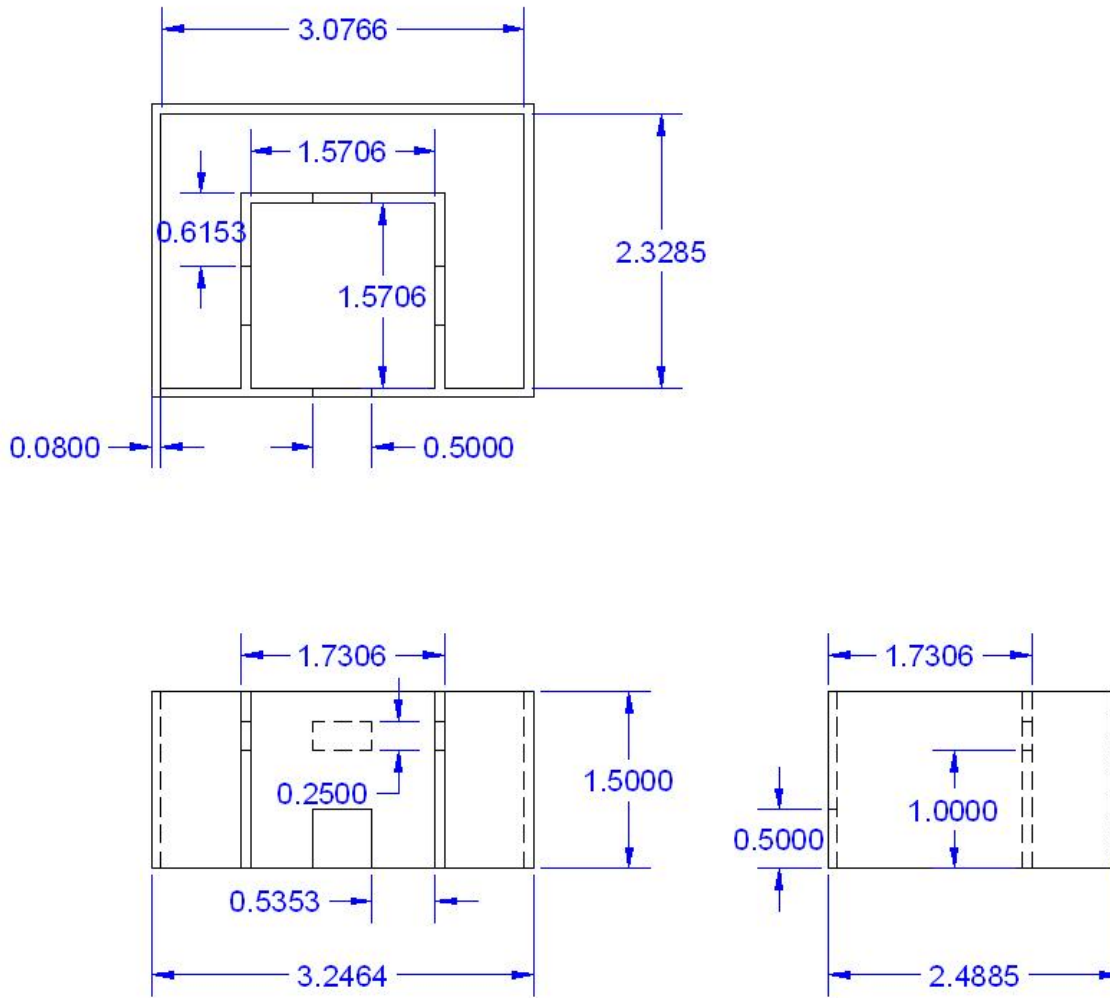

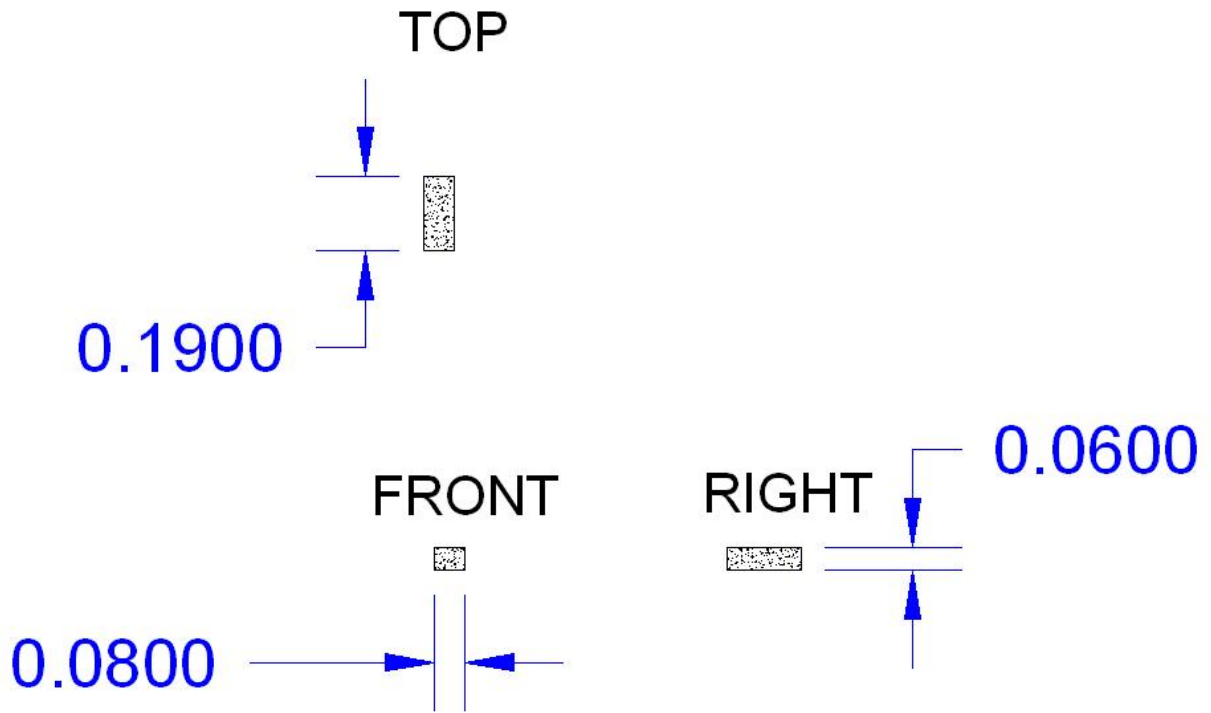

Figure C1: Brick Dimensions (meters)

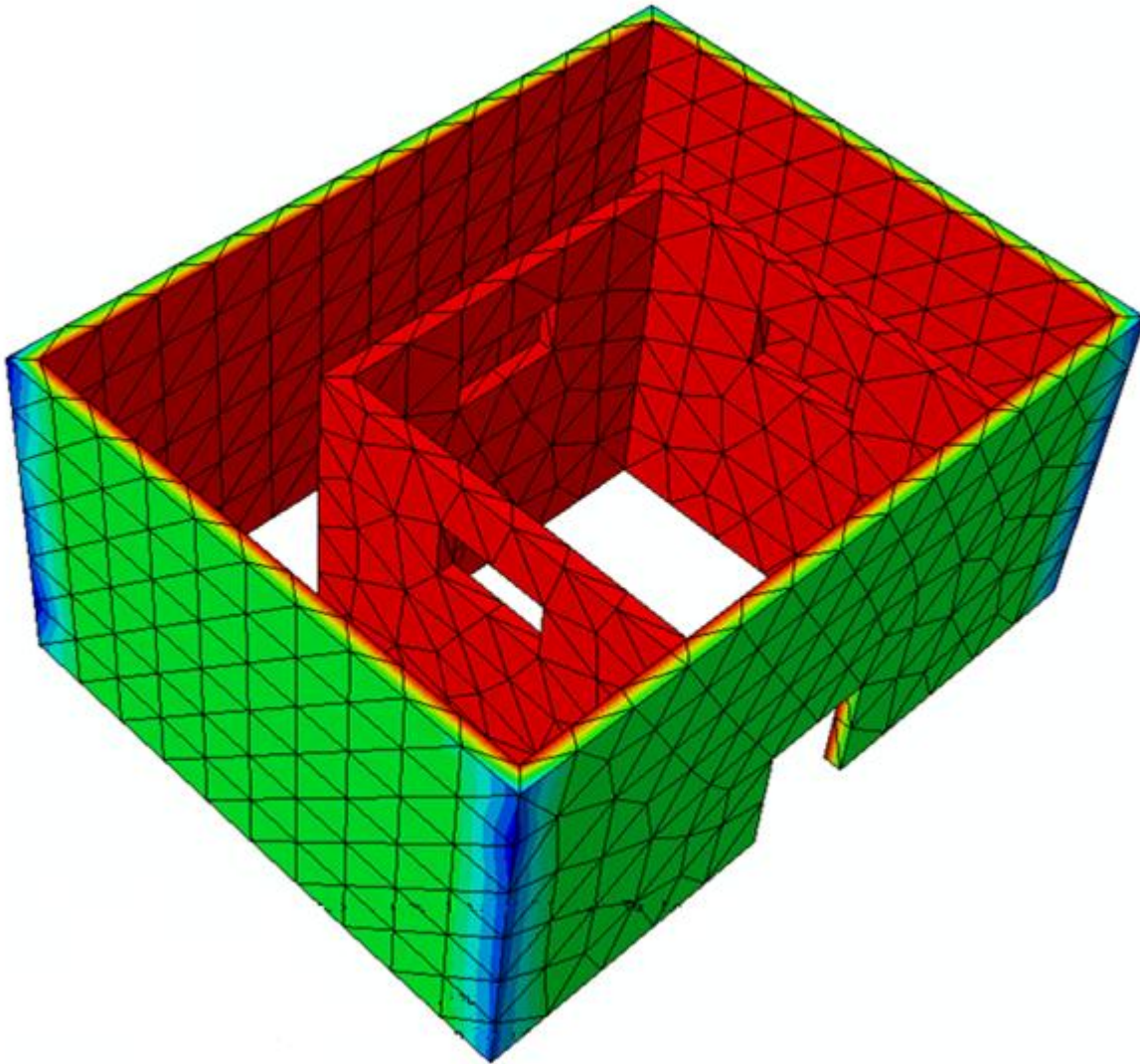
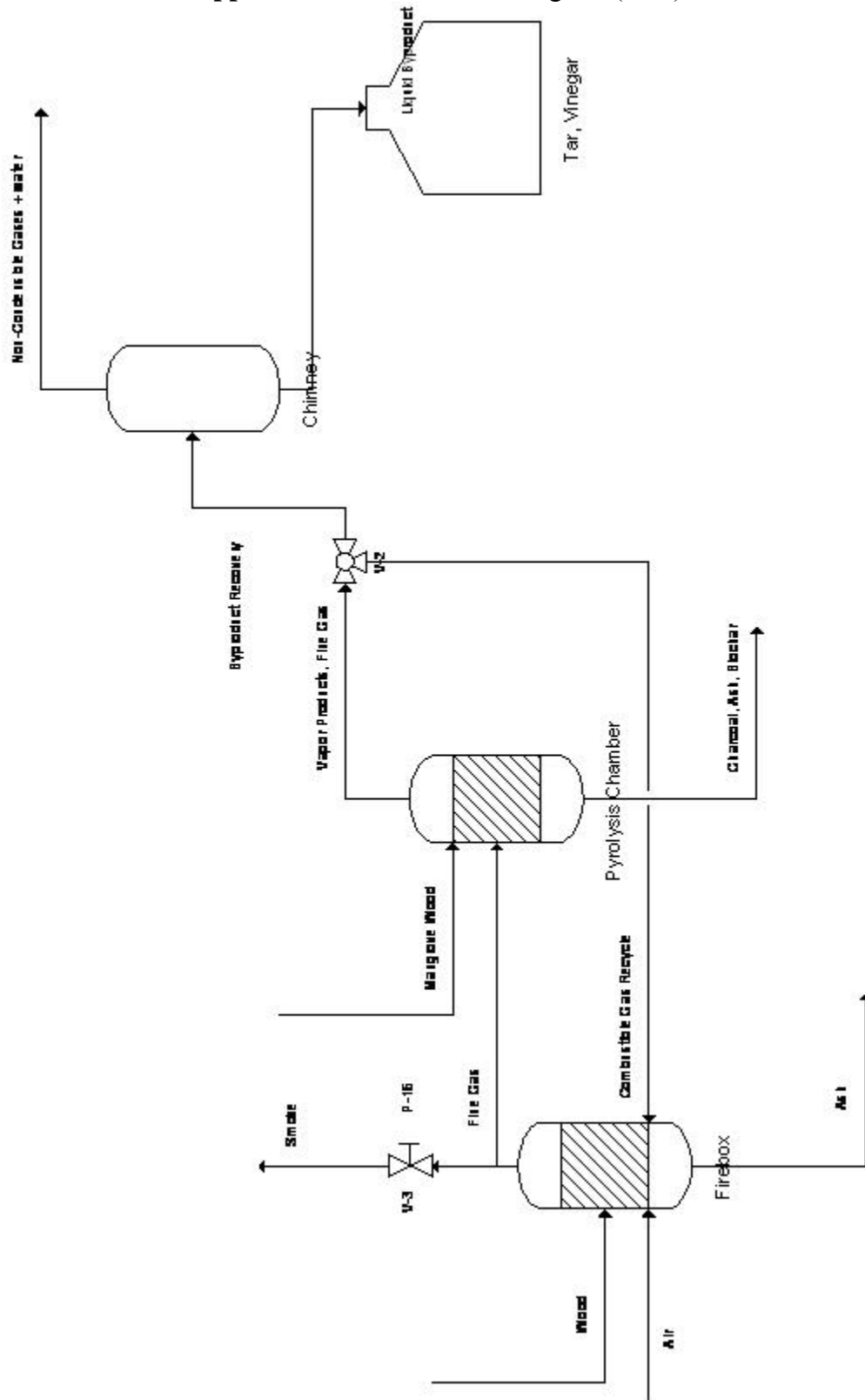

Figure C2: Representation of heat transfer and distribution through MCSES Design. The heat will largely remain in the firebox and pyrolysis chamber, as shown by the red. This represents a temperature of 520°F. The outer edges will remain cooler due to the insulative properties of the brick. To further keep heat inside the oven, dirt can be mounded around the outside. This model was designed in the program Abaqus.

Appendix D: Process Flow Diagram (PFD)



Appendix E: Table of Nomenclature

α	Thermal Diffusivity (BTU/sec-ft-R)
C_p	Specific heat capacity (BTU/lb _m -°F)
h	Heat transfer coefficient (BTU/sec-ft ² -R)
k	Thermal conductivity (BTU/sec-ft-R)
Q	Heat (BTU)
ρ	Density (lb _m /ft ³)
R_c	Rate of constant drying (lbm/sec)
T	Temperature (°F)
T_0	Initial temperature (°F)
T_1	Final temperature (°F)
ΔT	Change in temperature (°F)
t	Time (seconds)
λ_w	Latent heat of water (BTU/lb _m)
Λ	Latent heat (BTU/lb _m)
m	Mass (lb _m)
η	Efficiency (%)
x	Distance (ft)
x_0	Initial distance (ft)
x_1	Final Distance (ft)
X	Graphical value used with Y (unitless)
Y	Temperature iteration (unitless)



Appendix F: Construction Schedule and Network

Table F1: Construction Schedule to build oven

Construction Schedule										
Activity	Description	Details	Duration (hours)	Work Days Required	Prerequisite Activities	Early Start Time	Early Finish Time	Late Start Time	Late Finish Time	Float
1	Prepare oven location	Level the ground, remove rocks, roots, trees, etc., compact earth to keep bricks from sinking	16	2.00	0	0	168	0	168	0
2	Collect materials	Order bricks, sheet metal, metal piping, mortar, grating sheet, fume hood (distillation device)	168	7.00	0	0	16	152	168	152
3	Lay outline of oven	Ensure correct sizing and brick placement for firebox and pyrolysis chamber	8	1.00	1, 2	168	176	168	176	0
4	Build oven walls	Ensure correct heights	32	4.00	3	176	208	176	208	0
5	Add grating level	Keeps wood off ground, giving space for ash to fall	1	0.13	4	208	209	210	211	2
6	Attach chimneys	Allows for ventilation of gases	3	0.13	4	208	211	208	211	0
7	Begin charcoal process	See Process Schedule	-	-	5, 6	211	-	211	-	0
Total:			228 hours	14.3 days						



MCSES Construction Schedule
(duration in hours)

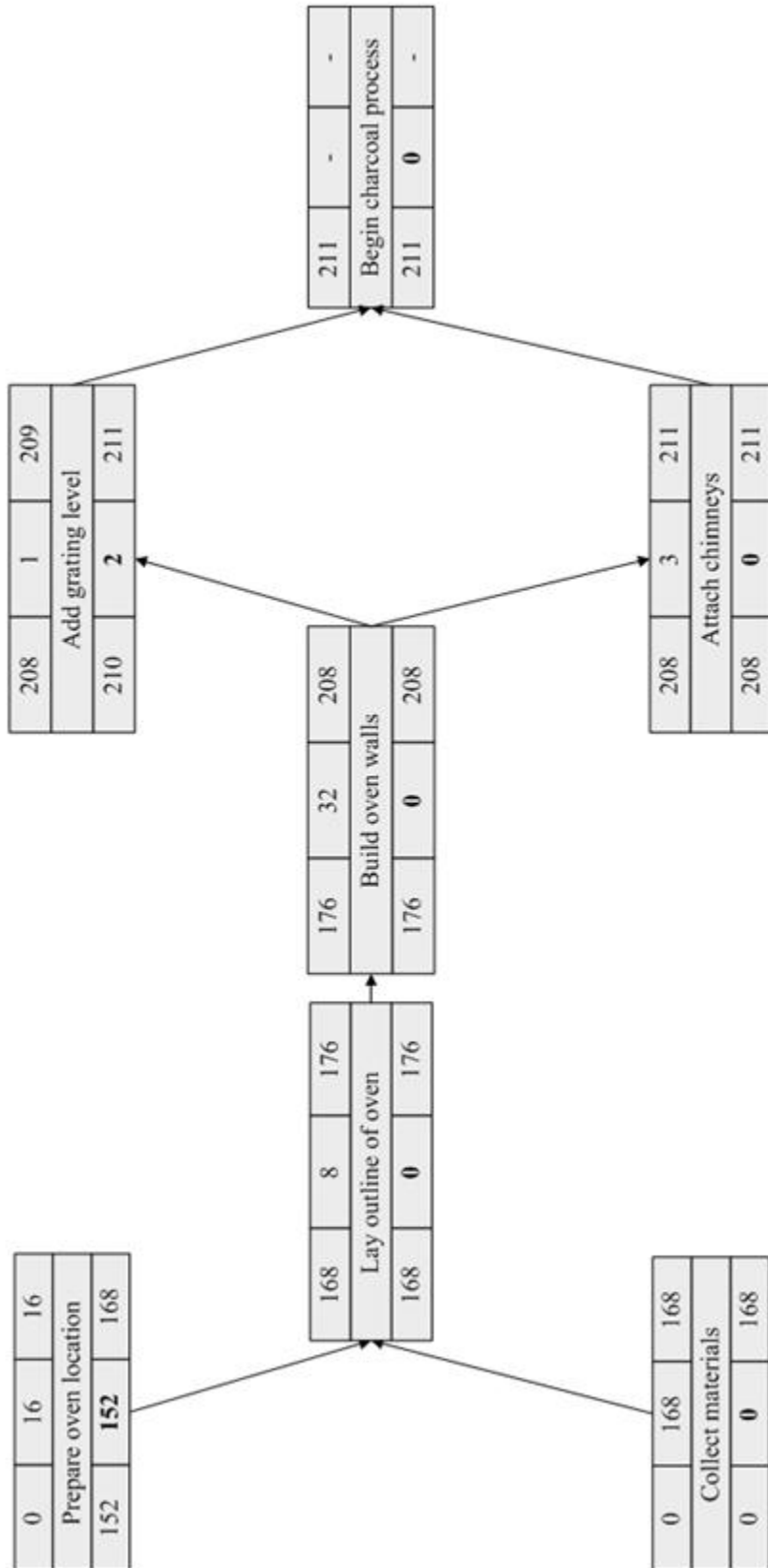

Appendix G: Process Schedule and Network

Table G1: Process Schedule to use oven for charcoal production

Process Schedule										
Activity	Description	Details	Duration (hours)	Duration (days)	Pre requisite Activities	Early Start Time	Early Finish Time	Late Start Time	Late Finish Time	Float
1	Collect wood	Need mangrove wood for charcoal and dry wood for firebox	32	4.00	0	0	32	0	32	0
2	Replant trees	Necessary for sustainable harvesting	32	4.00	1	32	64	66	98	34
3	Fill chambers	Mangrove wood in pyrolysis chamber, dry wood in firebox	8	1.00	1	32	40	32	40	0
4	Attach lid	Metal sheet laid over top of pyrolysis chamber using mortar	1	0.13	3	40	41	40	41	0
5	Start fire	Light the dry wood in fire box	1	0.13	4	41	42	41	42	0
6	Attach fume hood	When smoke changes color, attach fume hood to collect distillate	1	0.13	5	42	43	89	90	47
7	Pyrolysize mangrove wood	Wait until wood turned to charcoal, continuously add dry wood to firebox when needed	42	2.00	5	42	90	42	90	0
8	Douse fire	Use water or soil to put out fire in firebox	1	0.13	6, 7	90	91	90	91	0
9	Cooling period	All charcoal to cool	2	0.50	8	91	93	91	93	0
10	Collect charcoal	Remove lid and collect charcoal into appropriate containers	4	0.50	9	93	97	93	97	0
11	Cleaning oven	Remove excess ash and charcoal pieces, sweep out firebox	1	0.25	10	97	98	97	98	0
12	Repeat process		-	-	2, 11	98	-	98	-	0
Total:			125 hours	12.75 days						



MCSES Process Schedule
(duration in hours)

